

REDUCER SPEC	
MODEL	NMRV 130
SERVICE FACTOR	2.3
RATIO	30
OUTPUT [rpm]	66
OUTPUT TORQUE [Nm]	378.2
BACKLASH [arc-m]	6' - 12'
WEIGHT [kg]	43.5
MOTOR SPEC	
MODEL	HG-SR352
POWER [kW]	3.5
INPUT [rpm]	2000
WEIGHT [kg]	16

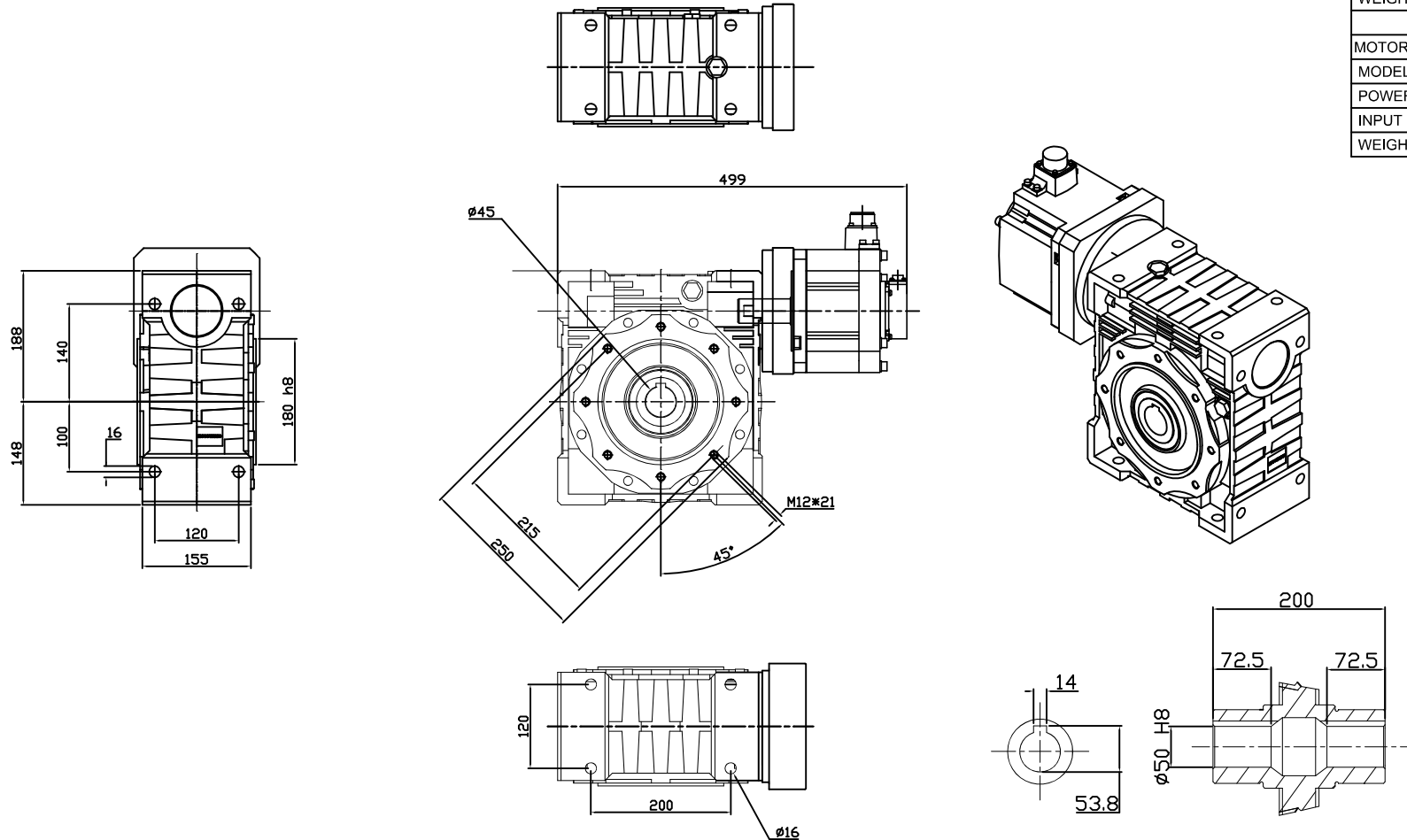

OUTPUT HOLLOW SHAFT

(주)한국체인모터

Tel. 032-815-8888 Fax. 815-8020
www.hcmfa.com

PROJECT		MOTOVARIO					
DRAWN	SEO Y.S	DATE		REV	A	SCALE	1:1
CHECKED	KIM J.S	DATE		UNIT	MM	PAGE	-
APPROVED	LEE J.Y	DATE		